

Kammunica Enterprise Wireless Network Topology

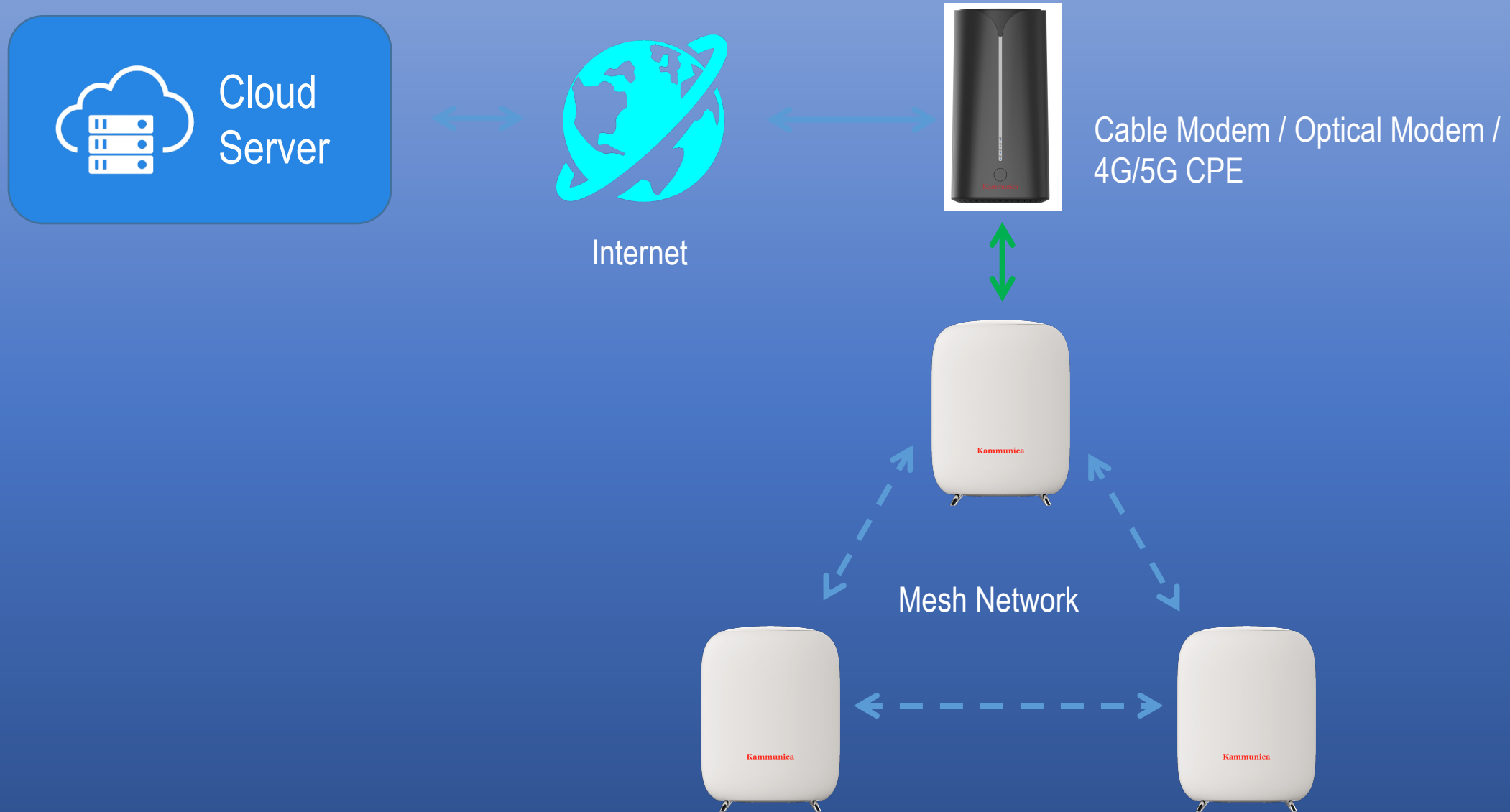

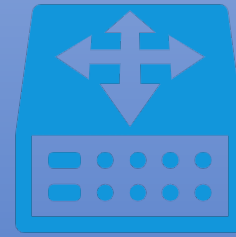

4G LTE / 5G CPE or Wired Router



S8P/S24P
POE Switch



D90/D30



D9C/D3C

FWA edge access solution: provide Wi-Fi service

- 4G LTE/5G 
- - - Mesh Wi-Fi
- Cat.6 Gigabit cable

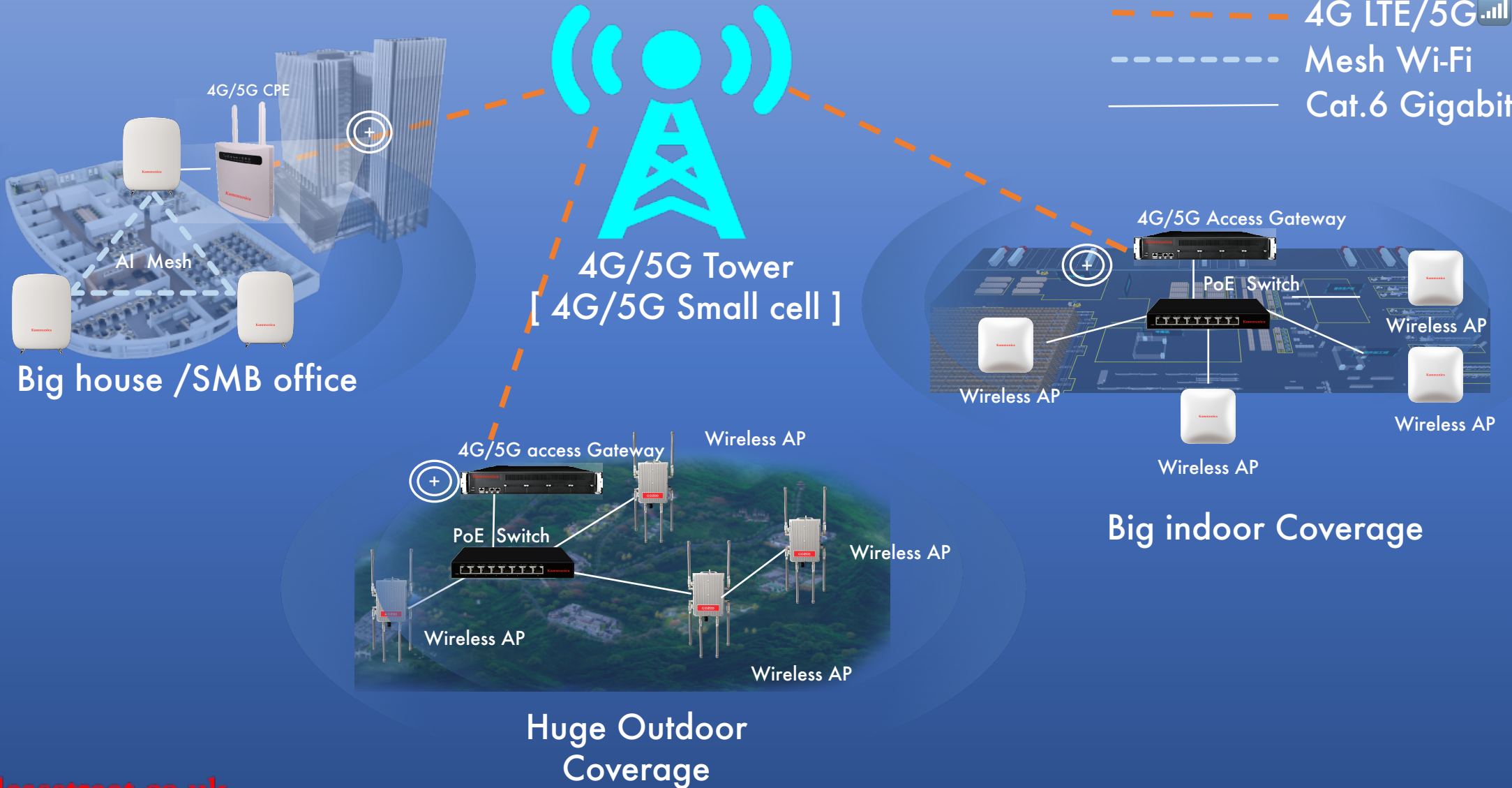

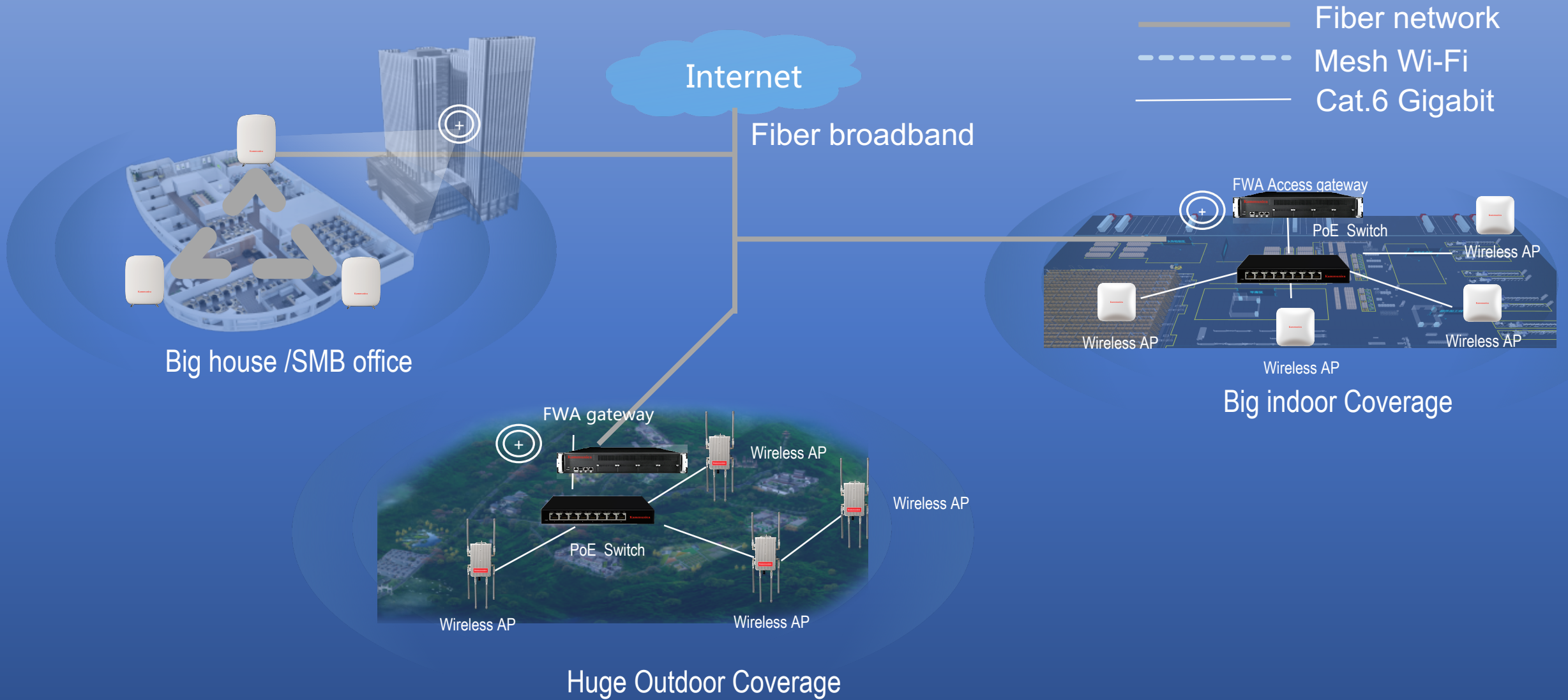

Kammunica 5G CPE IDU - M01MX01

Chipset:

- ✓ Processor: **IPQ8071A Quad-core ARM Cortex A53 @ 1.0 GHz**
- ✓ RAM: 16MB Flash + 128MB NAND + 2* 256MB DDR3
- ✓ 5G Modem: Qualcomm® **Snapdragon™ X55 Modem-RF System**

ü LTE-TDD: B34/B38/B39/B40/B41/B42/B43/B48

ü LTE Down 4 × 4 MIMO: B1/B2/B3/B4/B7/B25/B30/B32/B34/B38/B39/B40/B41/B42/B43/B48/B66

ü WCDMA: B1/B2/B3/B4/B5/B8/B19

ü LTE: Down 1.0 Gbps; UP 200 Mbps

5G:

- ✓ 5G Network Modes: SA(standalone), NSA (non-standalone)
- ✓ 5G NSA Bands: n38/n41/n77/n78/n79
- ✓ 5G SA Bands: n1/n2/n3/n5/n7/n8/n12/n20/n25/n28/n38/n40/n41/n48*/n66/n71/n77/n78/n79
- ✓ 5G Standards: 3GPP Release 15
- ✓ 5G SA Transmission Speed: 2.1Gbps/900Mbps (up to ISPs)
- ✓ 5G NSA Transmission Speed: 2.5Gbps/650Mbps (up to ISPs)

4G:

- ✓ LTE Category: Down Cat 16/ UP Cat 18
- ✓ LTE
FDD: B1/B2/B3/B4/B5/B7/B8/B12/B13/B14/B17/B18/B19/B20/B25/B26/B28/B29/B30/B32/B66/B71



WiFi:

- ✓ Working Radio: #1: 600Mbps @ 2.4GHz; #2: 2475Mbps @ 5.1-5.8GHz
- ✓ Coding Technology: 1024-QAM / OFDMA
- ✓ Peak Connections: >500+ Clients
- ✓ Wi-Fi Standard Conformance: WiFi6 and 802.11ac / 802.11n backward
- ✓ Antenna: built-in 6 pcs high performance antennas with 6 pcs external FEM components.

Port:

- ✓ Ethernet: 1*2.5Gbps WAN, 2*LAN 1Gbps
- ✓ 1* SIM Slot (Nano-SIM)
- ✓ Reset button
- ✓ MESH+ Button
- ✓ MESH+ LED Switch
- ✓ LED Indicator
 - MESH+ Working Status (breathing light)
 - 4G Status
 - 5G Status
 - WiFi Status
 - Power Status
- ✓ DC12V/3A

Size and Weight:

- ✓ Size: 108X108X216mm
- ü Weight: 680g



Chipset:

- ✓ Processor: **MTK7621AT**
- ✓ RAM: 16MB Flash + 256MB DDR3
- ✓ 5G Modem: Qualcomm® **Snapdragon™ X55 Modem-RF** System

5G:

- ✓ 5G Network Modes: SA(standalone), NSA (non-standalone)
- ✓ 5G NSA Bands: n38/n41/n77/n78/n79
- ✓ 5G SA Bands:
n1/n2/n3/n5/n7/n8/n12/n20/n25/n28/n38/n40/n41/n48*/n66/n71/n77/n78/n79
- ✓ 5G Standards: 3GPP Release 15
- ✓ 5G SA Transmission Speed: 2.1Gbps/900Mbps (up to ISPs)
- ✓ 5G NSA Transmission Speed: 2.5Gbps/650Mbps (up to ISPs)

4G:

- ✓ LTE Category: Down Cat 16/ UP Cat 18
- ✓ LTE

FDD: B1/B2/B3/B4/B5/B7/B8/B12/B13/B14/B17/B18/B19/B20/B25/
B26/B28/B29/B30/B32/B66/B71

ü LTE-TDD: B34/B38/B39/B40/B41/B42/B43/B48

ü LTE Down 4 × 4

MIMO: B1/B2/B3/B4/B7/B25/B30/B32/B34/B38/B39/B40/B41/B42/
B43/B48/B66

ü WCDMA: B1/B2/B3/B4/B5/B8/B19

ü LTE: Down 1.0 Gbps; UP 200 Mbps



WiFi:

- ✓ Working Radio: #1: 600Mbps @ 2.4GHz; #2: 2475Mbps @ 5.1-5.8GHz
- ✓ Coding Technology: 1024-QAM / OFDMA
- ✓ Peak Connections: >500+ Clients
- ✓ Wi-Fi Standard Conformance: WiFi6 and 802.11ac / 802.11n backward
- ✓ Antenna: built-in 6 pcs high performance antennas with 6 pcs external FEM components.

Size and Weight:

- ✓ Size: 108X108X216mm
- ü Weight: 680g

Port:

- ✓ Ethernet: 1*2.5Gbps WAN, 2*LAN 1Gbps
- ✓ 1* SIM Slot (Nano-SIM)
- ✓ Reset button
- ✓ MESH+ Button
- ✓ MESH+ LED Switch
- ✓ LED Indicator
 - MESH+ Working Status (breathing light)
 - 4G Status
 - 5G Status
 - WiFi Status
 - Power Status
- ✓ DC12V/3A



Product Introduction

M01MX01 is a highly advanced 5G indoor multi-service product solution specifically designed to meet integrated data, and 802.11b/g/n/ac High speed Wi-Fi access needs for residential, business and enterprise users. It enables wide service coverage and provides high data throughput and networking features to customers who needs easy broadband access, hot-spot Wi-Fi connectivity.

Feature Highlights

- w Built-in high gain 5G Sub6G antenna
- w Full compliance to 3GPP 5G NR+4G LTE TDD/FDD-LTE
- w RJ45 Gigabit Ethernet
- w 802.11b/g/n/ac Wi-Fi support
- w Router, bridge , IPv4 & IPv6
- w FTP/HTTP Server and TR-069 client management support
- w SIM card authentication



Product Main SPEC

Item	Description
Chip Platform	5G/LTE Modem: Unisoc IVY510, Dual-core ARM Cortex A55, up to 1.35GHz WIFI: Realtek RTL8198D, Dual-core MIPS interAptiv@900MHz
Memory	5G/LTE Modem: RAM 4Gb LPDDR4X + ROM 2Gb Nand RTL8198D: RAM 2Gb DDR3 + ROM 1Gb Nand
OS	Linux 4.4
Dimensions	215mm(High) x 105mm(Diameter)
Weight	About 706g
Support Bands	5G-NR: N1/N41/N77/N78/N79 FDD-LTE: B1/B3/B5/B8(or B28A/B28B) TDD-LTE: B34/B38/B39/B40/B41 Can be customized according to the customer's requirements
Interface	DC, Power Key, WPS Key, Reset Hole, Nano SIM Solt RJ45: 2 x Gigabit Port (1 LAN + 1WAN)
LED	5 LEDs with 3 colors, Wi-Fi, 4G Signal, 5G Signal, WPS, Power
SIM Card	1.8V/3V Nano SIM Card
Power Supply	DC 12V/2A
Carrier Aggregation	DL: 3CA UL: 2CA
MIMO	5G: DL MIMO 4*4, UL MIMO 2*2 LTE: MIMO 2*2 WIFI: MIMO 2*2(5GHz), MIMO 2*2(2.4GHz)
DL modulation	LTE: 64-QAM 5G Sub6: 256-QAM
UL modulation	LTE: 64-QAM 5G Sub6: 256-QAM
Peak data rate	5G: 2Gbps DL/ 1Gbps UL, LTE: 300Mbps DL/ 150Mbps UL Notes: This is maximum theory speed, depend on the network support
Wi-Fi	802.11a/b/g/n/ac 2.4GHz 2x2MIMO 11n, ~300Mbps 5GHz 2x2MIMO 11ac, ~867Mbps

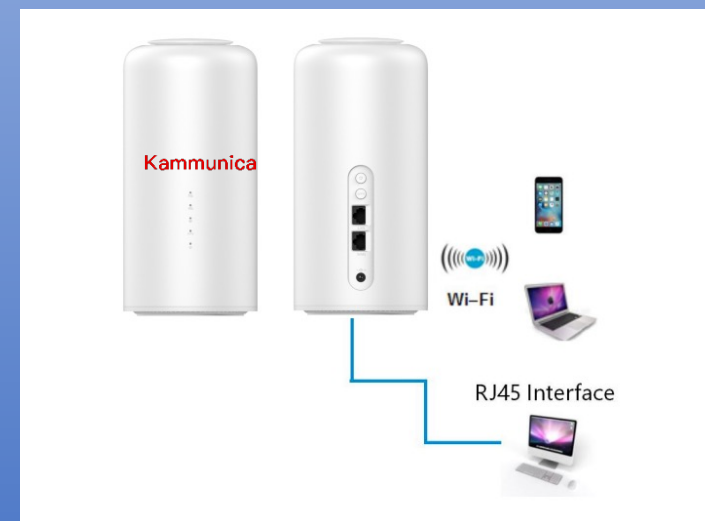

R5102 Product Introduction R5102 is a highly advanced 5G portable multi-service product solution specifically designed to meet integrated data, and 802.11b/g/n/ac High speed Wi-Fi access needs for businessman, traveller and outdoor users. It enables wide service coverage and provides high data throughput and networking features to customers who needs easy hot-spot Wi-Fi connectivity.

Product Feature Highlights

- Portable high speed Wi-Fi access
- 2.0 inch IPS LCD display with easy interactive menu
- Built-in high gain 5G Sub-6GHz antenna
- Full compliance to 3GPP 5G NR+4G LTE TDD/FDD
- IEEE 802.11b/g/n/ac Wi-Fi support
- SIM card authentication



Product Specification

Item	Description
Chip Platform	Unisoc T7510, 4*A75@2.0GHz + 4*A55@1.8GHz
Band	WCDMA: B1/B2/B5 FDD-LTE: B3/B7/B8 TDD-LTE: B34/B38/B39/B40/B41 5G-NR: N41/N78/N79 Can be customized according to customer's requirement
Display	2.0 inch IPS LCD, 480*360
Battery	Li-ion Polymer, 5000mAh(Typ)
Power Supply	USB Type C, 5V/2A
SIM Card	Nano SIM
Keys	Power Key, Menu Key
Carrier Aggregation	DL: 2CA UL: 2CA
MIMO	4*4
DL modulation	LTE: 64-QAM 5G Sub6: 256-QAM
UL modulation	LTE: 64-QAM 5G Sub6: 256-QAM
Peak data rate	5G: 2.45Gbps DL/ 1.25Gbps UL, LTE: 300Mbps DL/ 150Mbps UL Notes: This is maximum theory speed, depend on the network support
Wi-Fi	802.11a/b/g/n/ac 2.4GHz 2x2MIMO 11n, ~300Mbps 5GHz 2x2MIMO 11ac, ~867Mbps
Dimensions	168.4*79.6*13mm
Weight	TBD

Key parameters

- Maximum download speed: 5Gbps
- Support LTE Cat.20, LTE Advanced 7-band Carrier Aggregation, 4x4 MIMO, 256QAM
- Support 16pcs device online simultaneously.
- Wi-Fi 802.11ax 2.4GHz/5GHz Concurrent dual frequency
- iOS/Android App: Support process view monitoring, management equipment, network settings, etc.

Spec / Band

- Multi-gigabit Platform - 5G enabled with LTE fallback
- LTE CAT 20 (2Gbps)
- Up to 7X Carrier Aggregation
- 3G Bands: B1/2/4/5/6/8/19
- LTE Bands:

B1/2/3/4/5/7/8/12/13/14/17/18/19/20/25/26/28/29/30/32/34/38/39/40/41/42/43/46/48/66/71

• 5G Sub-6GHz Band: n1/n2/n3/n5/n7/n8/12/n20/n25/n28//n38/n41/n66/n71/n77/n78/n79

• 5G mmWave Band: n257/n258/n260/n261

• IPv4/IPv6 Dual-Stack Support

Main Chipset

• Qualcomm SDX55 + QCA6391

WiFi

• WiFi 802.11 b/g/n/ax 2.4GHz (2x2)

• WiFi 802.11 a/n/ac/ax 5GHz (2x2)



Spec

interface:

- USIM

Data management

- Manage your data and how much you use

Size

- 137 (L) x 75 (W) x 17.0 (H) mm

Weight

- TBD

LCD

- 2.4" LCD screen w/ touch panel

Battery

- 4000 mAh battery (Not removable)

Port

- USB 3.1 (Type-C) Port
- Quick Charge 3.0





Spec / Band

- Support: LTE Cat.20 (2Gbps), LTE Advanced 7-band Carrier

Aggregation, 4x4 MIMO, 256QAM

- LTE band:

B1/2/3/4/5/7/8/12/13/14/17/18/19/20/25/26/28/29/30/32/34/38/39/40/41/42/48/66

- 5G Sub-6GHz band: n1/n2/n3/n5/n7/n8/n12/n20/n28/n38/n41/n66/n77/n78

- 5G mmWave band

-- n260/n261 : North America

-- n257/n258 : Europ / Asia

Main Chipset

- QSC: SDX55

- Marvell AQC111C (5GbE)

LAN port

- 5Gbps Ethernet * 1 (w/ 802.3bt PoE PD)



Port

- USIM
- eSIM (optional)
- 3 color LED

Size & Weight:

- 230 (L) x 230 (W) x 65 (H) mm & 1550g (Weight)

Environment parameter

- IP65
- Operaton temperture: -20 ~ 55°C
- Easy to installation
- PoE power supply

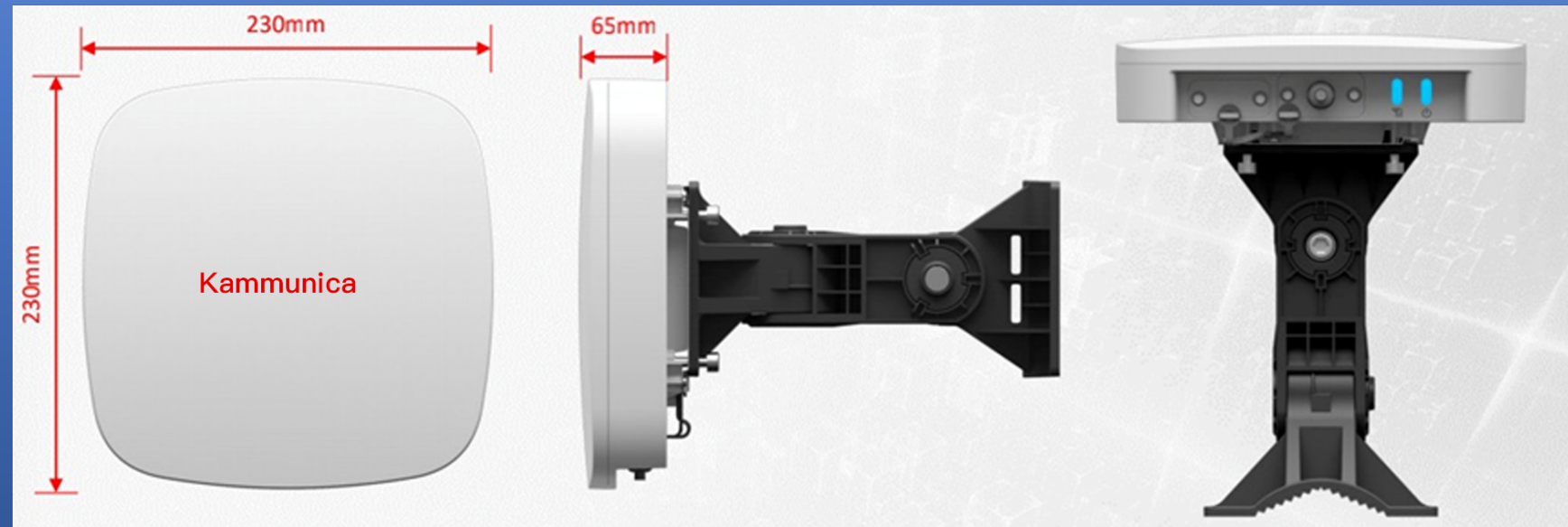

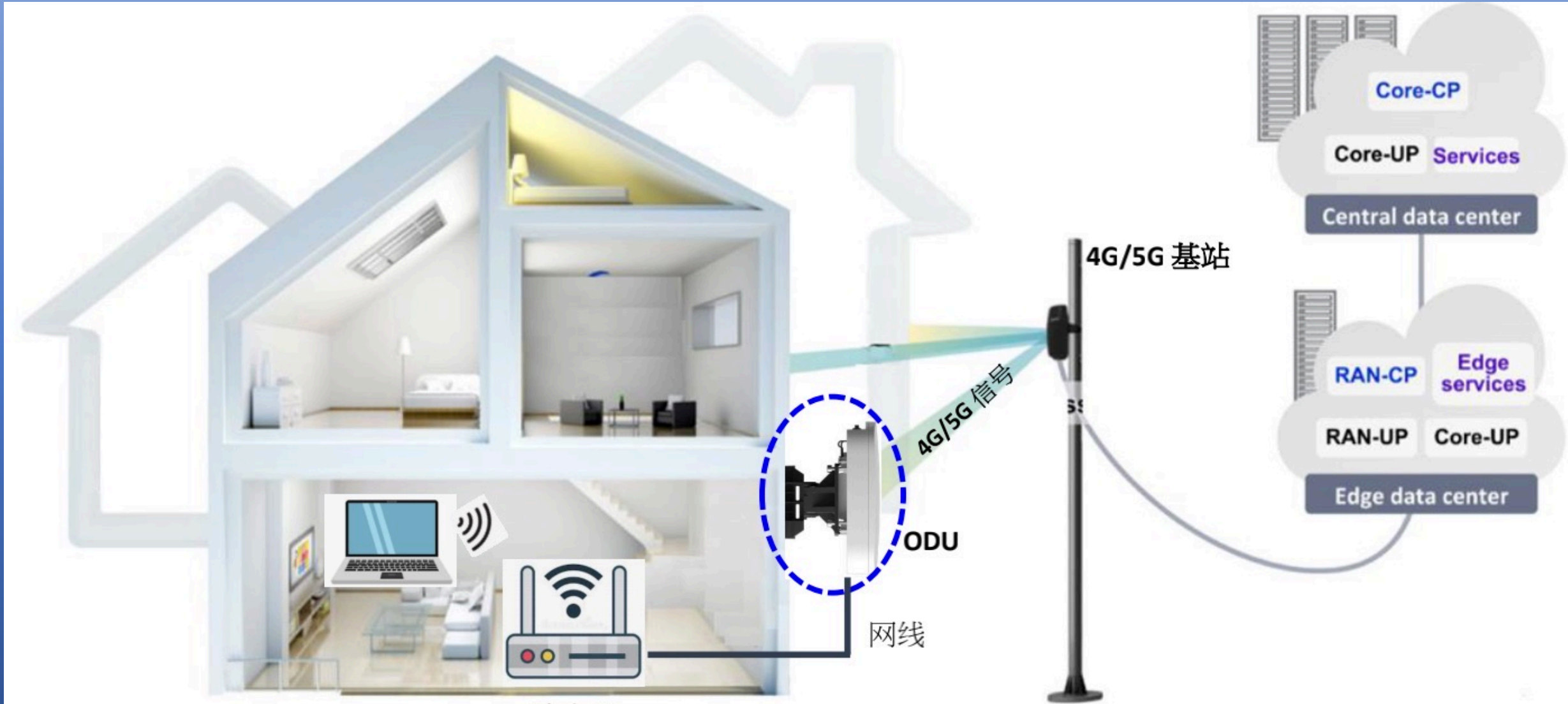

5G Disitribute Small Cell

5G RAN NR-5G Distribute Small Cell



5G NR RAN



5G vBBU



5G HUB



5G RRU

5G NR RAN

Introduction

Our NR RAN is 5G distributed small cell which is a distributed 5G small base station designed based on the CRAN and ORAN standard architecture, BBU + HUBB + RU.

Kammunica Wirelessstreet invested heavily and R & D personnel to successfully launch 5G NR RAN products which possess rich, open interfaces and application programming interface (API) capabilities Interoperability between components from different vendors through southbound interfaces.

Develop rich applications and services through northbound interfaces to provide operators with flexible networking models and innovative business types; Accelerate software and hardware decoupling at the same time.

In terms of software, the baseband unit (BBU) can be integrated with the existing software functions of the operator; In terms of hardware, through the generalization of hardware, operators can introduce cloud-based BBUs into general-purpose computing platforms to reduce equipment hardware costs.

Product innovations:

Intelligent wireless networks will be a key component of future communication networks. Signalwing gathers various aspects of R & D talents and integrates such advantageous technologies as cloud computing, big data, edge computing, artificial intelligence, and IT infrastructure with 5G Combined, the 5G NR RAN product integrates many aspects of technology and functions, and is an innovative product with absolute advantages in the current wireless communication.

Features:

Support X86 server platform, support all protocol stack functions of control plane and data plane, and support CU, DU and RU separation architecture.

Through the introduction of a Central Control Unit, on the one hand, it can achieve unified management of wireless resources and centralized control of mobility at the service level, thereby further improving network performance; on the other hand, at the architectural level, CU can be flexibly integrated. When it comes to the operator's cloud platform, it can also be designed with cloudization on a proprietary hardware environment to achieve resource pooling and deployment automation, reduce OPEX / CPAX, and improve customer experience.

The product supports diversity reception of 4 uplink antennas, with a maximum of 4 streams per cell, and preferably supports 4 downlink antennas, with a maximum of 4 streams per cell.

The product can achieve 100MHz bandwidth and 74% downlink ratio, the downlink peak throughput of the cell is not less than 1.5Gbps, and the uplink peak throughput of the cell is not less than 300Mbps.

Support 1000 UE / sectors in the active state at the same time, support 500 UE / sectors in the connection state at the same time.



Our 5G distributed small cell is a distributed 5G small base station based on the ORAN standard architecture, BBU + HUB + RRU.



Our 5G distributed small cell is 5G small base station based on the ORAN standard architecture, BBU + HUB + RRU.

Product Features

Scalability

Expansion unit expansion capability:

Supports expansion of 8 RRUs Cascade expansion capability.

Support cascade expansion 4 level HUB DC remote power supply capability.

Support up to 8 remotes for simultaneous POE power supply

Extending the distance: using optical fiber, 2km

Host interface: a 40G QSFP optical interface, a 10G SFP optical interface, and a 10GE RJ45 interface

Cascade interface: one 40G QSFP optical interface, three 10G SFP optical interfaces

Remote interface: 8 10G SFP fiber interfaces

Noise Reduction: Supports 8 RRU forwards

Merger, the noise floor degradation after the merger does not exceed 7dB

Power consumption: The power consumption of the whole machine is 45W, and the power supply capacity is 550W

220V-260V AC power supply

Weight and volume: 430mm * 370mm * 89mm (standard 19-inch 2U chassis), weight: 9.5kg

Installation: support 19-inch cabinet or wall-mounted installation

Protection level: IP30

Working environment: Temperature: -5 °C ~ + 55 °C Humidity: 15% ~ 95%



5G RRU

Connect with HUB, it support SFP fiber optical or 10G Ethernet Cable Port.

Key feature

- | Power supply: POE power supply or DC power supply
- | Physical interface: debug port: 1G network port External connection port: 1 10G Ethernet interface
- | Data transmission: 10G Ethernet (with shielded category 7 line) fronthaul, supporting CPRI / eCPRI protocol
- | Long distance: the distance of the network cable is not less than 100m
- | Transmission mode: 5G single mode: 4 receive and 4 send, and support 2 5G base station listening
- | 5G + 4G dual-mode: 5G channel 2 receives 2 transmissions, 4G channel 2 receives 2 transmissions and supports one channel of 4G base station listening and one channel of 5G base station listening
- | Full-duplex mode: supports both FDD and TDD modes
- | Supports bandwidth: it can support up to 4MHz channel 100MHz bandwidth and 5G channel 100MHz bandwidth
- | Antenna: Support 5G internal antenna
- | Operating time: MTBF> 200000H

Item	Parameter	
Working Frequency	Standard Working Frequency: 1805MHz-1880MHz、2515MHz-2675MHz、3400MHz-3500MHz and 3500MHz-3600MHz; Maximum Support: 600MHz~6000MHz	
Each Port Maximum Output Power	21dBm \pm 2dB	
Transmit off power	<-89dBm/MHz	
Output power control range	0 – 20dB with step of 1dB	
Emission	Meet 3GPP TS 38.104 of 6.6.5.2.1 (Category B)	
EVM	64QAM	< 5%;
	256QAM	<3.5%
Frequency Error	\pm 0.05ppm	
Time Sync	< 1us	
Receive maximum input power	-30dBm	
Noise Figure	< 5dB	
LO leak	>-38 dBc	
Power Consumption	2 Channels : 35W 4 Channels : 45W	
IG Grade	IP30	
Install Method	Supports various installation methods such as wall mounting and ceiling mounting	
EMC	Comply with 3GPP TS 38.113 (2017-12), adopt joint grounding method, and can work normally when the grounding resistance is less than 10 Ω	